



MERLIN[®]
TITANIUM



This cover is printed on 100 lb. Acadenim, a 100% recycled product made from blue jeans and used paper.

The text pages are printed on 100 lb. Pheno-Grand EF from Scheufelen North America, made of 50% recovered paper fiber.

Embossed by Oxford Bookbinding Company.

Printed by Lebanon Valley Offset, Annville, Pennsylvania.

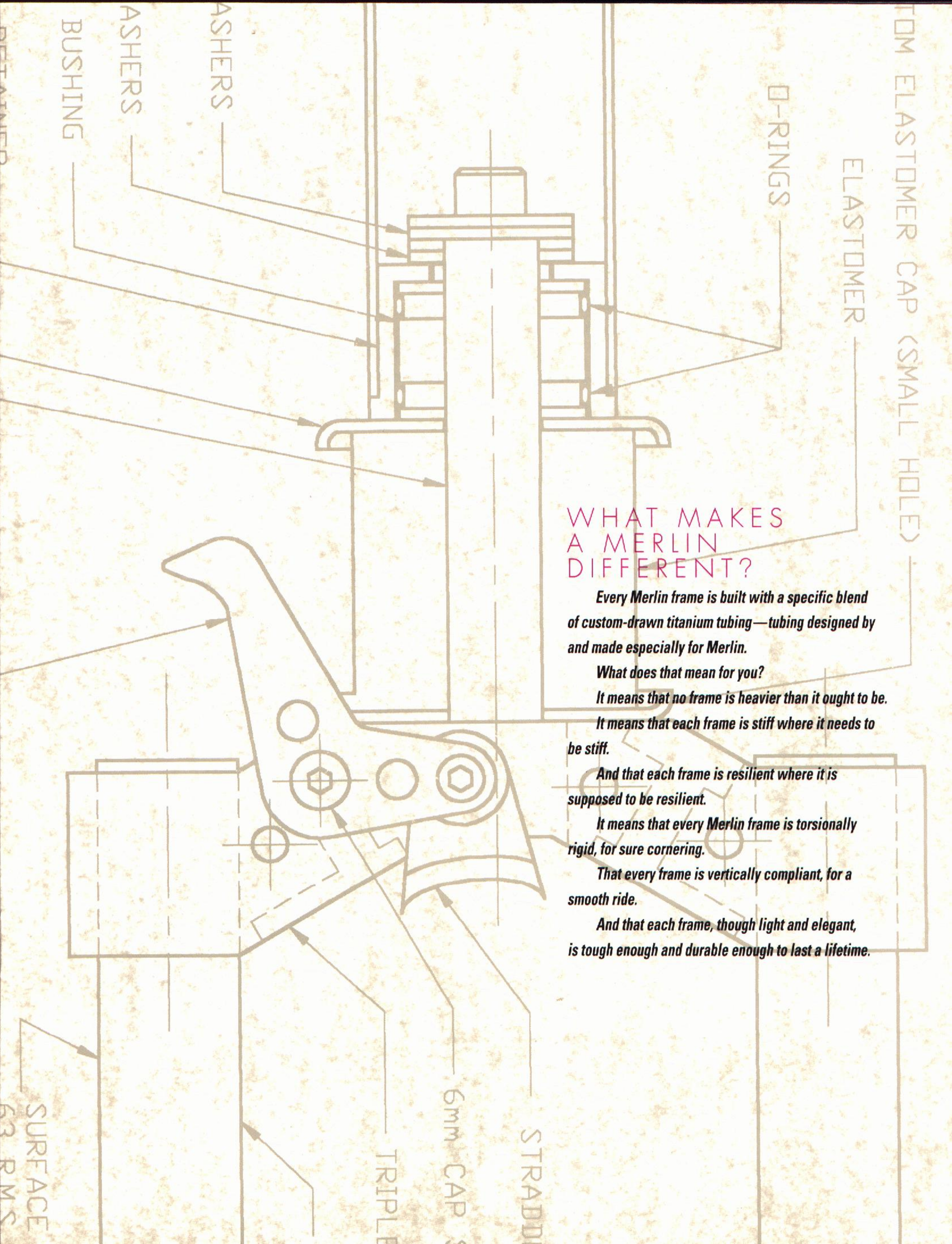

WHAT MAKES A MERLIN DIFFERENT?

Every Merlin frame is built with a specific blend of custom-drawn titanium tubing—tubing designed by and made especially for Merlin.

What does that mean for you?

It means that no frame is heavier than it ought to be.

It means that each frame is stiff where it needs to be stiff.

And that each frame is resilient where it is supposed to be resilient.

It means that every Merlin frame is torsionally rigid, for sure cornering.

That every frame is vertically compliant, for a smooth ride.

And that each frame, though light and elegant, is tough enough and durable enough to last a lifetime.

TITANIUM IS JUST THE BEGINNING

To start with, Merlin 3-2.5 titanium tubing comfortably exceeds all aerospace specs. We don't buy any scrap or seconds. We don't use so-called "sports grade" tubing, either. Instead, every piece is made to order, 1000 feet at a time, just for us.

Our tolerance for straightness is ± 0.010 " per foot, because that's the only way we can guarantee a straight frame.

Our tolerances for ovality and wall thickness are similarly strict, to make sure our frames ride the way we designed them to ride.

And to protect our customers' investment, the history of each tube is traceable from start to finish, through every inspection and quality-assurance step at the tube mill, right back to the foundry, all the way to the ingot.

There are a lot of reasons why we are such fanatics about our tubing, but this might be the most important: Every Merlin frame has a custom tube set. That is, every size we build, in every style, whether Extralight, Road, Mountain, or Suspension—30 different frames in all—every one is designed with a particular blend of Merlin tubing for optimum performance.



Machined from solid 6-4 titanium, our vertical dropouts cannot rust and will not break, but they will maintain perfect wheel alignment.

Talk about durable: Our seat collar is extra-thick and precision welded. It takes a standard 27.2-mm seatpost and adjusts effortlessly every time.



That means, for example, that the down tube in a 49 centimeter Extralight is entirely different in wall thickness and diameter from a 56. And the 56 is different from a 61.

And not just the down tube. Top tubes, seat tubes, seatstays, chainstays—they're all specifically selected for each frame.

Extralight frames have seamless double-buttet tubing, the first such production tubing ever made by anyone, anywhere. Suspension frames get seamless ovalized chainstays, still the only stays of their kind in the world. The V-Bends on our Road frames and the S-Bends on our Mountain frames are all specific, too. Every one.

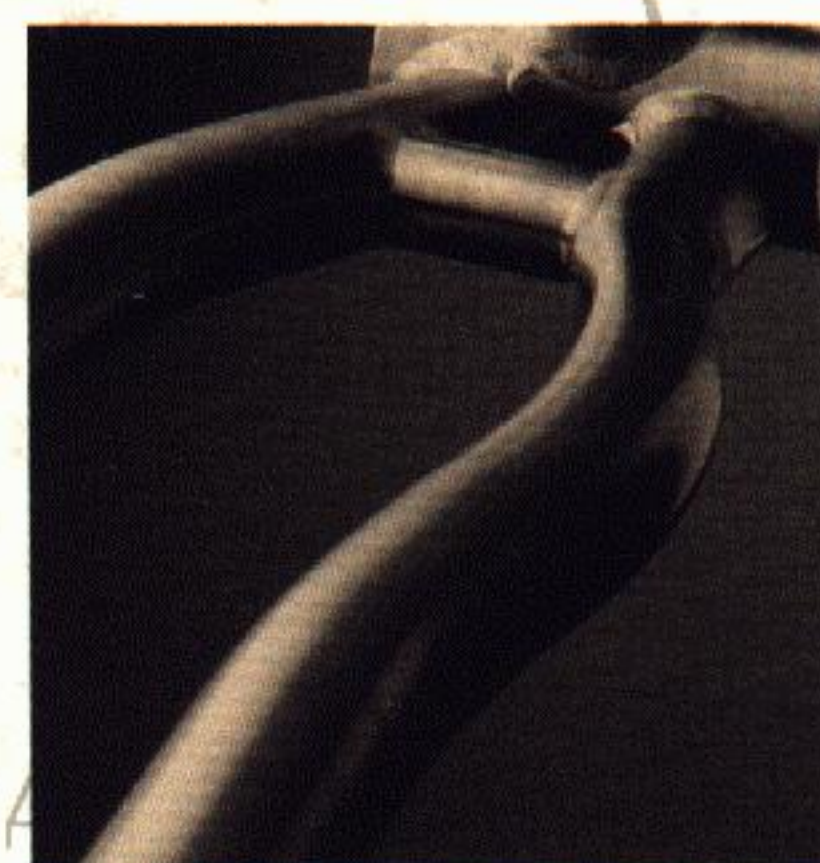

S-Bend mountain chainstays, made from strong and rigid 7/8-inch tubing, leave plenty of room for 2.6-inch tires and low-profile cranks.

Our exclusive large diameter V-Bend road chainstays (double-buttet on the Extralight) add terrific lateral stiffness for sure cornering.

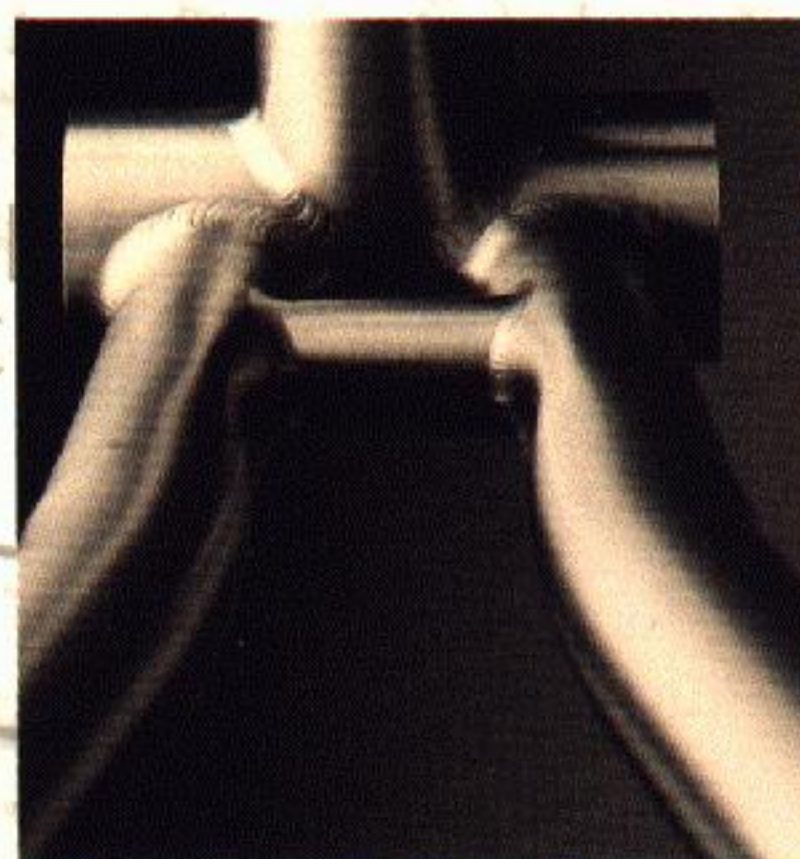

THREAD M10 X 1.0

57cm TOP TUBE THICK SECTION

I.D. ± 0.000

DOUBLE BUTTED TOP TUBE

57cm SEAT TUBE THIN SECTION

57cm SINGLE BUTTED SEAT TUBE

MATERIAL: MERLIN TITANIUM 3-2.5

57cm SEAT TUBE THICK SECTION

72.8°

59.9°

61.9°

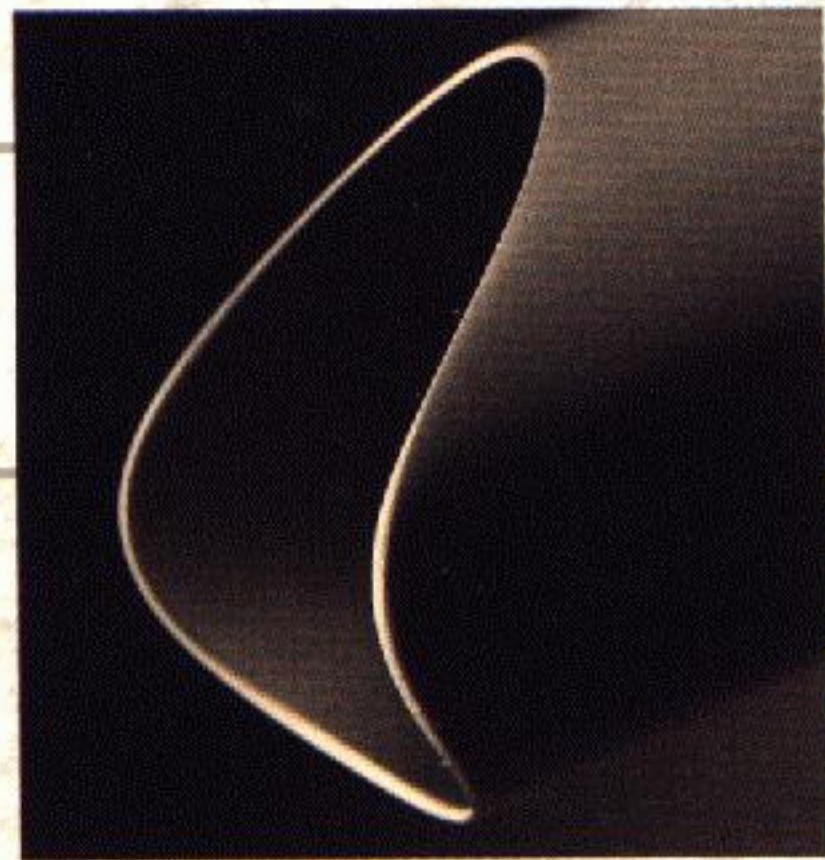

57cm TOP TUBE THICK SECTION

Merlin's 3-2.5 tubing is 46% lighter than steel, 200% higher in fatigue strength-to-weight, and so strong it shrugs off normal wear and tear.

57cm DOUBLE XL HEAD

MATERIAL: MERLIN 3-2.5

MATERIAL: MERLIN TITANIUM 3-2.5

SURFACE FINISH 8/16 R.M.S.

106.5°

We make our own seamless double-butted tubing, shown here in the Extralight head tube, to cut weight without affecting strength or longevity.

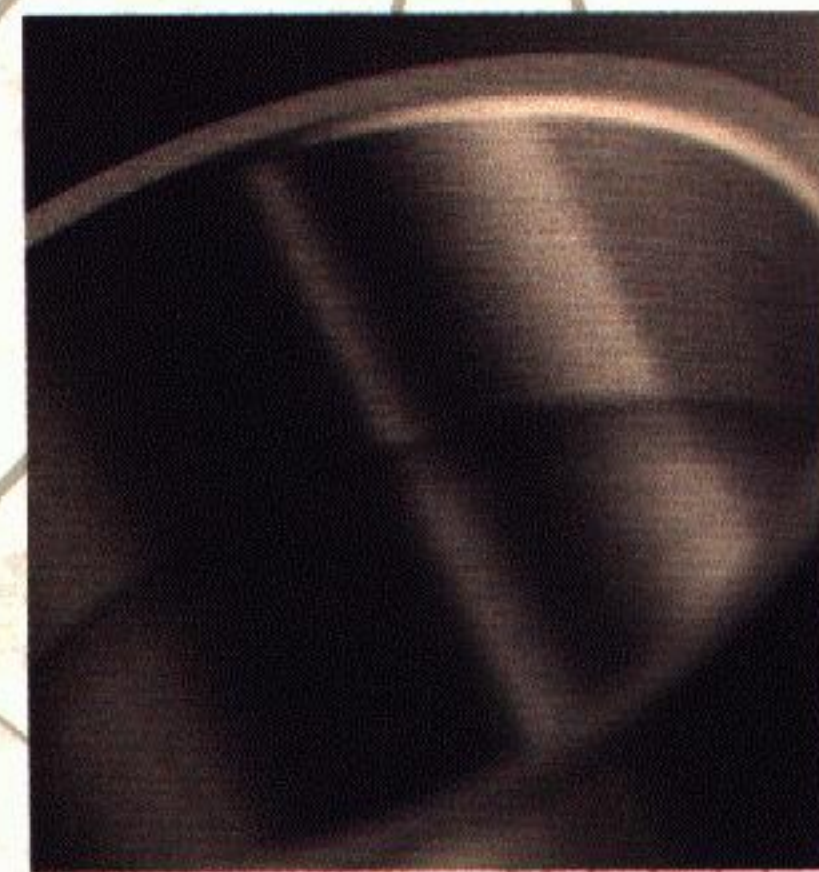

We developed this approach because the old ways of doing things don't always work with titanium. And we wanted to build better bicycles, even if doing it our way turned out to be harder.

Our threaded bottom bracket is a case in point. Other frames start with a threaded shell, which is then welded into place. Sounds obvious, but if you do it that way, it's impossible to keep the shell from distorting under the heat of welding. The frame will never be straight, and you will never get the bottom bracket adjusted properly.

So we do the unobvious: We start with an unthreaded piece of custom-made tubing that's thick enough to minimize distortion, and we build the frame around it. Then we secure the frame within a master alignment fixture and bore out the extra metal, carefully positioning the centerline perpendicular to the frame axis. With perfect alignment now assured, and with the frame still secured in the same fixture, we cut the threads and face the shell. Finally, we undercut the metal between the threads to further reduce weight.

It's difficult and expensive, and it took us almost two years to refine the process and fixtures, which may be why no one else does it.

But it's the right way to build a titanium bike.

We also pioneered the use of 6-4 titanium vertical dropouts, integral seat collar reinforcements, and ultra-rigid tubular brake bridges.

We set the standard for our mitering tolerances to a miniscule ten-thousandths of an inch.

We obtained costly, ultra-strong 6-4 weld wire, and we use it on all our frames.

And we developed a durable satin finish that looks so good you would never know that it practically takes care of itself.

Why bother?

Because if we did any less, you'd feel it.

If instead, however, you get off your bike at the end of the day with a big grin, then we know we've done our job.

Because that's the way we think bikes should be, too.

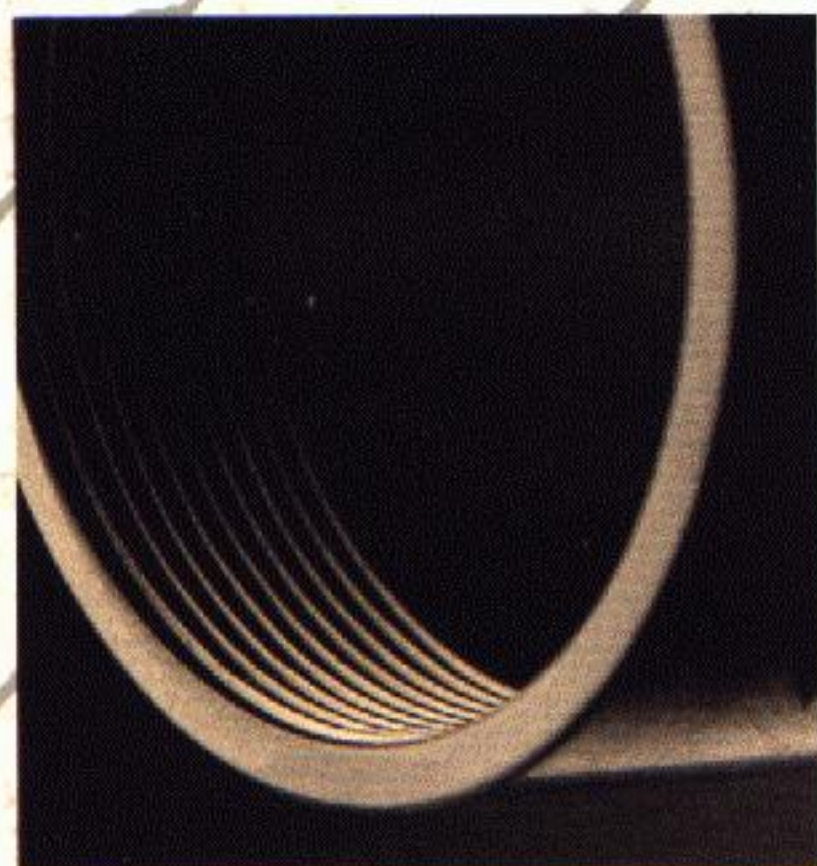

Weld first, thread later: That's the secret for perfect alignment of our custom bottom bracket shell. Why doesn't everyone do it this way?

57cm DOWN TUBE THICK SECTION

ALUMINUM DEPT

MERLIN EXTRALIGHT

Backed by three years of research and development, and more than 200,000 miles of professional competition with the Subaru-Montgomery team, the Merlin Extralight is, simply, a racing bicycle without compromise.

Handling is quick and sharp. Acceleration is instantaneous, with no flex in out-of-the-saddle climbs. Cornering is all but telepathic. Yet the Extralight still boasts the smooth ride that made Merlin famous.

The precise specifications in Merlin's seamless double-butted tubing guarantee

centimeters. Weights drop as low as a feathery 2.42 pounds, yet the Extralight is tough, solid, and race-ready, versatile enough to excel in criteriums, time trials, triathlons, and stage races.

MERLIN ROAD

The Road model's geometry, shared with the Extralight, features roomy top tubes, short wheelbases for proper weight balance, and low bottom brackets that impart stability without sacrificing cornering clearance.



optimum distribution of stress loads, better management of unwanted flex, and longer frame life. The top tube, down tube, head tube and chainstays are all double-butted, while the seat tube is single-butted at the bottom bracket (and reinforced with an integral sleeve at the seat collar). In this way, extraordinary strength is maintained at the welds, while a controlled amount of resiliency is permitted in the thinner center spans to deliver supple wheel control and matchless comfort.

The specific blend of custom tubes in each Extralight assures exceptional performance in every size, from 49 to 61

As with all Merlins, the resilient main triangle takes the edge off fatiguing ride harshness. Straight-gauge 7/8-inch V-Bend chainstays add lateral rigidity to the drivetrain for sure climbing and cornering, while seatstays and dropouts borrowed from the Extralight cut weight without affecting strength or reliability.

The Road's exquisite ride, low weight, and exceptional durability have made it the best-selling titanium frame in the world. Its all-round design is suitable for road races, century rides, and long-distance tours.



MERLIN SUSPENSION

The Merlin Suspension frame is something entirely new: an integrated, single-strut system that incorporates the suspension within the frameset.

It does not depend upon a complex linkage, nor even require a swingarm. Instead, the Suspension frame boasts a brilliantly simple pivotless design, lighter and less complicated than any other by far.

At the heart of the Merlin system are custom-made 3-2.5 titanium chainstays. Their unique Flat-Oval shape offers one inch of vertical travel without the lateral slop that plagues linkage and pivot designs. Additional springing and damping functions are supplied by a progressive-rate elastomer, which can be replaced in minutes to suit changing conditions.

Though light and comfortable, the Merlin is not bound by the ill-handling limitations of ordinary suspension designs. Instead, it is agile and responsive, and suffers no bobbing or porpoising motions on long climbs.



But it is the Suspension's ability to simply swallow rocks and rough trail that ultimately sets it apart. Since it's a true cross-country bike, you can maintain a quicker pace, choose a faster line, cut a

sharper turn, and clear a rutted trail more easily and with more control. All this without giving up the durability and precision of a Merlin.

Available in limited numbers.

MERLIN MOUNTAIN

Featuring large-diameter custom-drawn tubing and our exclusive asymmetrical S-Bend chainstays for maximum efficiency, the World Championship-winning Mountain frame is the standard by which off-road bikes are judged.

The 7/8-inch S-Bends are 50 percent stiffer than 3/4-inch stays, yet they clear 2.6-inch tires with room to spare.

Top tubes on all sizes are generously proportioned for proper weight distribution. Their sloping design cuts weight, improves standover clearance, and supplies additional ride compliance over rough terrain.

Nimble, light and quick, the Mountain frame is at home on narrow, root-infested trails, winding singletrack, sharp, rocky climbs, and fast fire roads.



STRENGTH, WEIGHT AND DURABILITY

Strength is one of the most important considerations for a bicycle frame. Yield strength is the point at which a material permanently deforms (where it bends and stays bent). Ultimate (tensile) strength is the breaking point.

However, all metals lose strength after welding. Thus, the most meaningful basic comparison for strength is with the material in its welded condition, as shown at right.

Although ultimate strength is important, most frame failures are caused by fatigue—that is, from the regular stresses that occur on each ride. All other things being equal, high fatigue strength means long frame life.

Another important consideration is frame weight, which is a function of the material's strength-to-weight ratio; the higher the ratio, the lighter the frame can be.

If you combine these concerns—strength after welding, fatigue strength, and weight—you obtain the fatigue strength-to-weight ratio, the most useful indicator of actual frame performance.

Sources: *Bicycle Metallurgy for the Cyclist*, Douglas Hayduk; Easton Aluminum, Inc.; Haynes International; *Machinery's Handbook*, 24th ed. (Industrial Press, Inc.); *Metal Fatigue in Engineering*, Fuchs and Stephens; Tange USA; *Welding in 3-2.5 Tubing*, Chan and McMahon, University of Pennsylvania.

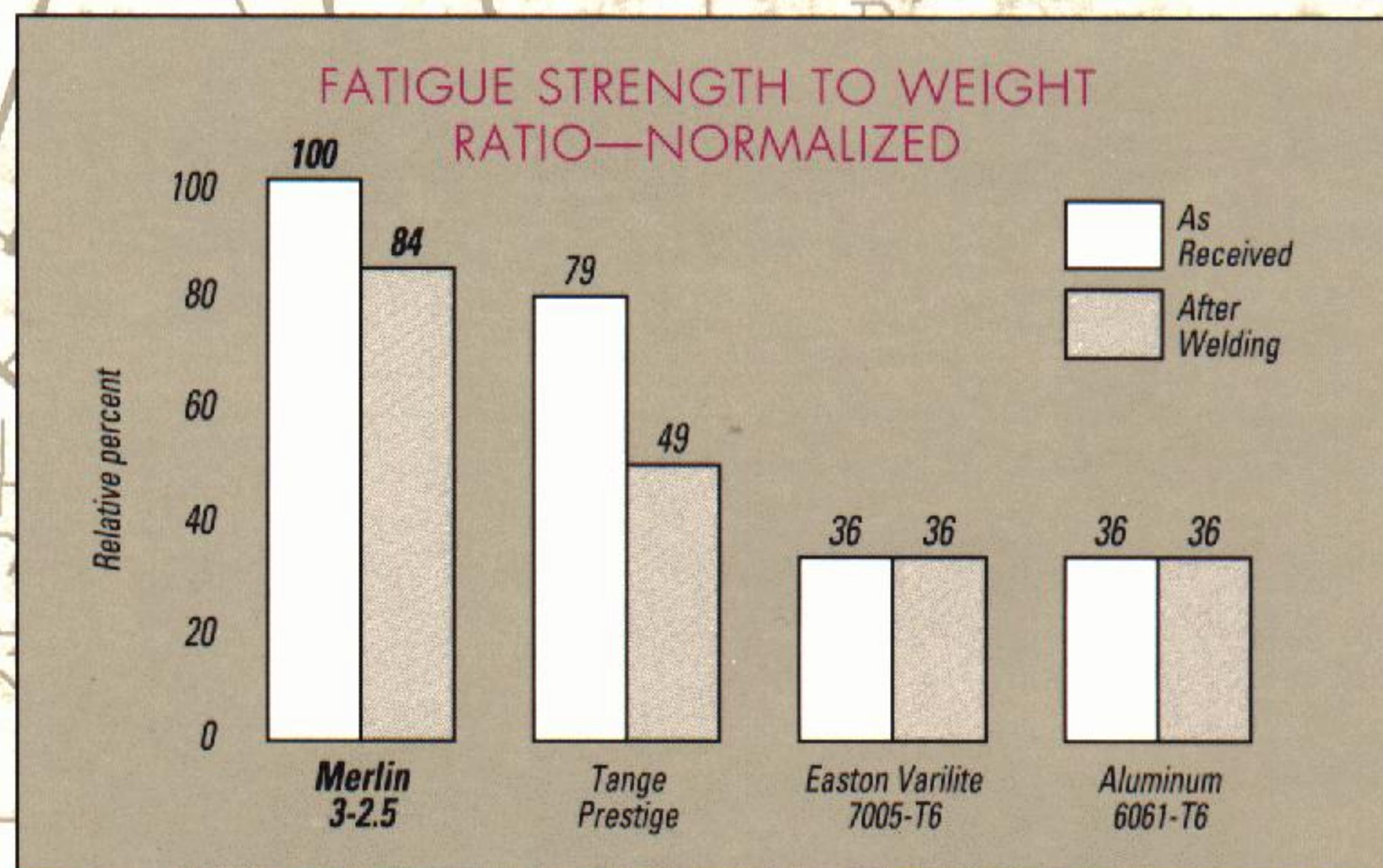
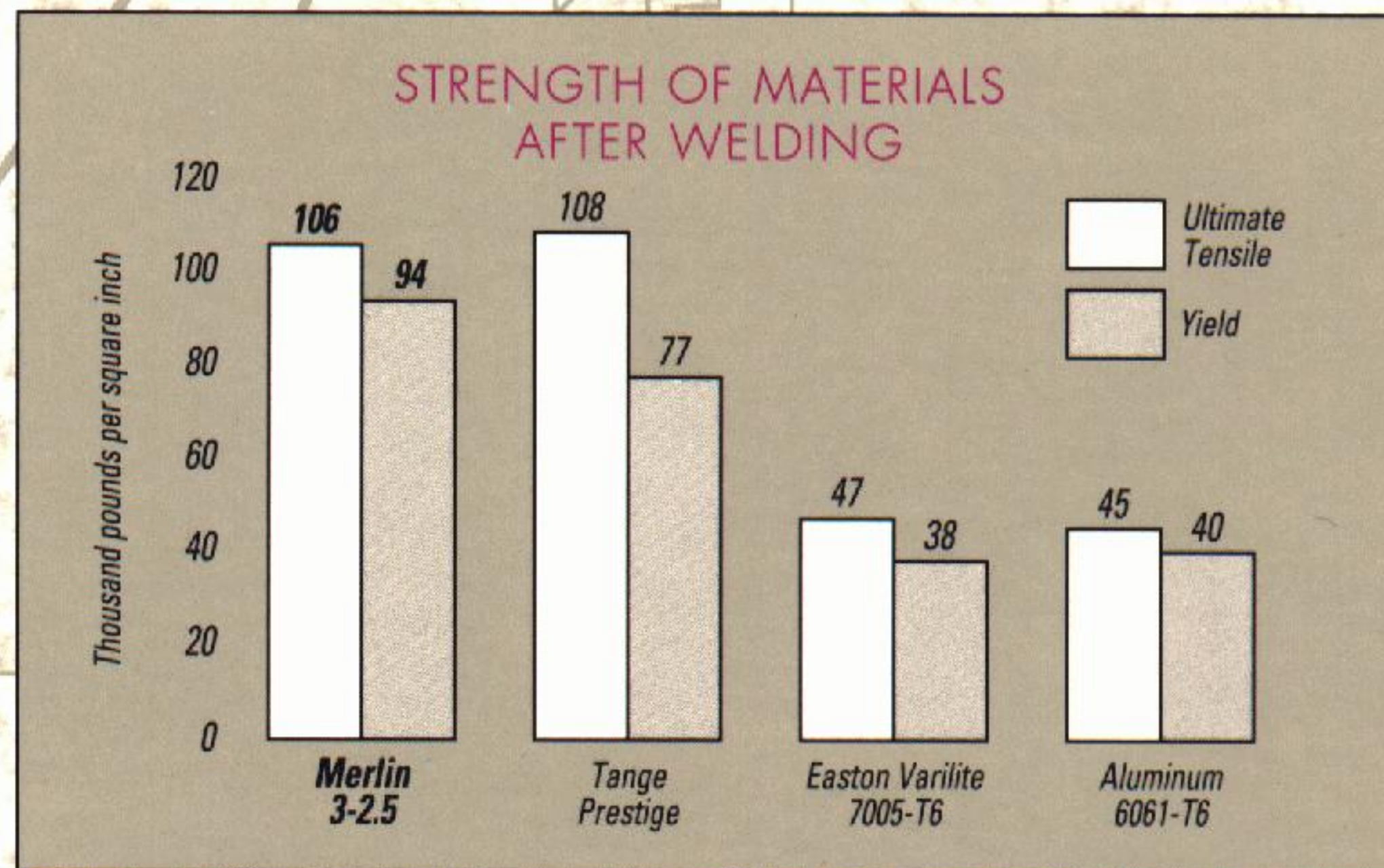

SIZING INFORMATION

ROAD FRAMES: For an approximate calculation of your correct frame size, measure your inseam in centimeters, crotch to floor in bare feet, and multiply by 66 percent. Frame sizes are measured from the center of the bottom bracket spindle to the top of the top tube at the seatpost binder (not to the top of the seat tube extension).

MOUNTAIN FRAMES: For an approximate calculation of your correct frame size, measure your inseam in inches, crotch to floor in bare feet, and subtract 16 inches. When in doubt, choose a smaller frame size, especially if your legs are long in proportion to your upper body. Frame sizes are measured from the center of the bottom bracket spindle to the center of the top tube at the seatpost binder. "Nominal" top tube lengths are measured as if the tube were horizontal (parallel with the ground).

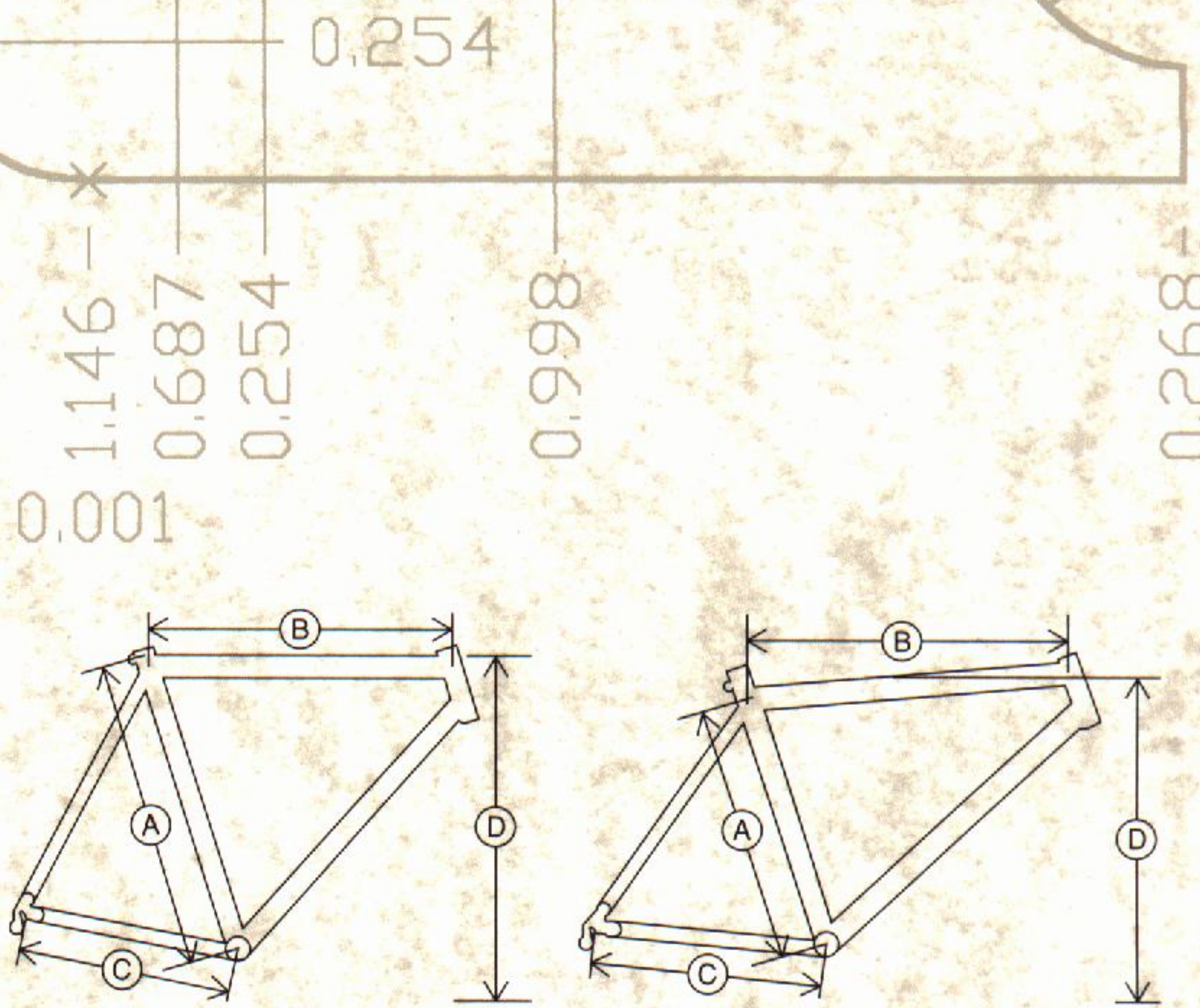

ROAD FRAMES

- A: Seat tube, center to top of top tube
- B: Top tube, center to center
- C: Chainstay, center to center
- D: Standover, top tube to ground

MOUNTAIN FRAMES

- A: Seat tube, center to center
- B: Top tube, center to center, horizontally
- C: Chainstay, center to center
- D: Standover, midspan of top tube to ground

MERLIN EXTRALIGHT

Frame Size (cm, center to top)	49	51	53	54	55	56	57	58	59	61
Head angle (degrees)	72.5	73.0	73.0	73.0	73.5	73.5	73.5	73.5	74.0	74.0
Seat angle (degrees)	74.0	74.0	74.0	73.5	73.5	73.0	73.0	73.0	73.0	72.5
Top tube (cm)	52.1	53.3	54.5	55.0	55.5	56.1	56.5	57.1	57.5	58.5
Chainstay (cm)	41.6	41.3	40.6	41.0	41.0	41.0	41.0	41.0	41.0	41.6
Wheelbase (cm)*	97.1	97.4	98.0	98.0	98.0	98.1	98.5	99.0	99.0	100.2
Standover height (cm)	73.8	76.0	77.9	78.6	79.7	80.3	81.4	82.3	83.4	85.5
Bottom bracket drop (cm)	7.3	7.0	7.0	7.0	7.0	7.0	7.0	7.0	7.0	6.7
Head tube length (cm)	6.6	8.6	10.5	11.4	12.0	12.8	13.8	14.8	15.6	17.8
Steerer length (cm)	11.2	13.2	15.1	16.0	16.6	17.4	18.4	19.4	20.2	22.4
Fork rake (cm)*	4.8	4.5	4.5	4.5	4.0	4.0	4.0	4.0	4.0	4.0
Frame weight (pounds)	2.42	2.47	2.55	2.60	2.66	2.68	2.69	2.79	2.92	3.09

* SR Prism fork

MERLIN ROAD

Frame Size (cm, center to top)	49	51	53	54	55	56	57	58	59	61
Head angle (degrees)	72.5	73.0	73.0	73.0	73.5	73.5	73.5	73.5	74.0	74.0
Seat angle (degrees)	74.0	74.0	74.0	73.5	73.5	73.0	73.0	73.0	73.0	72.5
Top tube (cm)	52.1	53.3	54.5	55.0	55.5	56.1	56.5	57.1	57.5	58.5
Chainstay (cm)	41.6	41.3	40.6	41.0	41.0	41.0	41.0	41.0	41.0	41.6
Wheelbase (cm)*	97.1	97.4	98.0	98.0	98.0	98.1	98.5	99.0	99.0	100.2
Standover height (cm)	73.8	76.0	77.9	78.6	79.7	80.3	81.4	82.3	83.4	85.5
Bottom bracket drop (cm)	7.3	7.0	7.0	7.0	7.0	7.0	7.0	7.0	7.0	6.7
Head tube length (cm)	6.6	8.6	10.5	11.4	12.0	12.8	13.8	14.8	15.6	17.8
Steerer length (cm)	11.2	13.2	15.1	16.0	16.6	17.4	18.4	19.4	20.2	22.4
Fork rake (cm)*	4.8	4.5	4.5	4.5	4.0	4.0	4.0	4.0	4.0	4.0
Frame weight (pounds)	2.74	2.86	2.97	3.02	3.06	3.23	3.39	3.50	3.61	3.90

* SR Prism fork

MERLIN SUSPENSION

Frame Size (in., center-center)	15.0	17.0	19.0
Head angle (degrees)*	71.0	71.5	72.0
Seat angle (degrees)*	73.5	73.0	72.5
Nominal top tube (in.)	22.00	23.00	23.75
Chainstay (in.)	16.75	16.75	16.75
Wheelbase (in.)*	41.00	41.75	42.12
Standover height (in.)*	29.0	30.0	32.8
Bottom bracket height (in.)*	11.6	11.8	11.9
Head tube length (in.)	3.75	4.25	5.50
Steerer length (in.)	5.5	6.0	7.0
Frame weight (pounds)	4.51	4.60	4.97

* Unloaded frame, Panaracer Smoke tires, Manitou fork

MERLIN MOUNTAIN

Frame Size (in., center-center)	13.5	15.0	16.25	17.5	18.75	20.0	21.5
Head angle (degrees)	70.5	70.5	71.0	71.0	71.0	71.5	72.0
Seat angle (degrees)	73.5	73.5	73.5	73.0	72.5	72.5	72.0
Nominal top tube (in.)	21.00	21.75	22.38	23.00	23.63	24.25	25.00
Chainstay (in.)	16.75	16.75	16.75	16.75	16.75	16.75	16.75
Wheelbase (in.)*	40.1	40.8	41.4	41.8	42.3	42.8	43.2
Standover height (in.)	27.4	28.3	29.2	30.0	30.9	32.1	33.3
Bottom bracket height (in.)	11.6	11.6	11.7	11.8	11.8	11.9	11.9
Head tube length (in.)	3.38	3.75	4.00	4.25	5.00	6.00	7.00
Steerer length (in.)	5.00	5.50	5.75	6.00	6.75	7.75	8.75
Frame weight (pounds)	3.18	3.25	3.36	3.46	3.58	3.70	3.92

* Ritchey Logic fork (1.75 in. rake)

EXTRALIGHT AND ROAD FEATURES

- Geometry by Tom Kellogg
- 7/8-inch V-Bend chainstays
- 27.2-mm seatpost diameter
- Derailleur clamp supplied with Extralight frame (1 1/4-inch on 49, 51, 53; 1 3/8 on all other sizes); 1 1/4-inch clamp required for Road frame
- 130-mm rear axle spacing
- Brake cable stops at 7 o'clock
- Chain peg (all sizes) and pump peg (54-61) standard
- Optional forks: Merlin Kinesis, SR Prism, Time Carbon
- Steerer lengths calculated with a 46-mm stack height; measure all parts before cutting the steerer tube
- Frame weight does not include fork or bottom bracket; all weights are approximate
- Standover heights vary with tire profile
- For custom sizes, paint, clearcoat and other custom options, please contact Tom Kellogg, Spectrum Cycles, 1190 Dorney Road, Breinigsville, PA 18031; 215-398-1986

SUSPENSION AND MOUNTAIN FEATURES

- Geometry by Rob Vandermark
- 7/8-inch S-Bend chainstays
- 27.2-mm seatpost diameter
- 1 1/4-inch derailleur clamp on 13.5; 1 3/8-inch clamp on all other sizes
- 135-mm rear axle spacing
- Dropouts have threaded eyelets
- Top tube cable routing is available at extra cost on Mountain frame
- Optional fork: Ritchey Logic
- Steerer lengths calculated with a 46-mm stack height; measure all parts before cutting the steerer tube
- Suspension geometry has been adjusted to compensate for rear elastomer compression under rider weight; Mountain geometry is compatible with standard aftermarket suspension forks
- All models have sloping top tubes; "nominal" lengths measured as if the top tube were horizontal
- Frame weight does not include fork or bottom bracket; all weights are approximate
- Standover heights vary with tire profile

Merlin frames are covered by a limited lifetime warranty; see the Merlin Owner's Manual for full details.

© 1993 Merlin Metalworks, Inc.
Specifications subject to change without notice.



Merlin Metalworks, Inc., 40 Smith Place, Cambridge, MA 02138 · 617.661.6688

Merlin Titanium S.A., Mont Choisi 1, CH-1854 Leysin, Switzerland · 41 25 34 38 00

For additional technical information and the name of your nearest Merlin dealer, please call.